

# STEEP ROOF

lights



Working light for precision

**LED**

Lighting series **JSS/JBS**

Lighting series **JSH/JBH**



Lighting series **JSSN/JSN/JBN**

JUNG steep roof luminaires and their variants are sheet steel lamps of high protection class and are especially suitable for use in paint spraying facilities, clean rooms and in the chemical industry. Their numerous different versions and variants satisfy every wish. The luminaire element on which all components can be found, is swivel mounted in its casing and interchangeable. These light fittings are built to a well-thought out design that enables easy cleaning. The cover of the light outlet consists of a frameless single pane of safety glass fitted flush to the casing. The pane can be quickly and comfortably opened with the use of a central lock.





#### FEATURES

- Types up to  zone 1 and 21 available
- Free of substances that inhibit paint wetting
- Powder-coated sheet steel light fitting
- Available in various widths
- High-quality LED modules
- Norm conformity of all lamps with 

#### STANDARD DESIGN

- Casing colour: RAL 9016 – traffic white
- Reflector: RAL 9016 – traffic white
- Cable inlet: 3 x M 25 screw connections – suitable for cable diameter of 7 - 17 mm
- Terminal: L1, N, PE – max. clamping range 4.0 mm<sup>2</sup>
- Glass: 6 mm single-pane toughened safety glass

#### OPTIONS

- Powder coating in all RAL colours
- Polished stainless steel finish
- Connection via diverse connector systems
- Ready-to-install delivery with cable attached
- Dimmable versions
- 5-pole wiring L1, L2, L3, N, PE
- Various light temperatures
- Special voltages / frequencies
- Brackets for fixing the light fittings
- Versions with circuit breaker for a complete switch-off whenever the light fitting is opened
- 3- or 5-pole feedthrough wiring
- Glass with stickers, printed or etched

#### ACCESSORIES FOR JSS + JBS

- Galvanised M8 eye bolt for hanging lights
- Knotted-link chain of any length with appropriate snap hooks in galvanised finish
- Wall and ceiling brackets for swivel lights
- Special fixing parts made to client specifications





Due to the amount of possible versions and variants, the JUNG luminaire series JSS and JBS are able to cope with all assembly situations and the -protection up to zone 1 and 21.



## TECHNICAL DATA



### JSS1LED

#### JSH1LED

- Suitable for  zone 1 and 21
- Approval EU specimen certification of inspection
- Explosion protection  II2G Ex eb mb op is qb IIC T4 Gb
-  II2D Ex op is tb IIIC T70° C Db
- CE mark
- LED-Driver
- Ambient temperature -20° C to + 50° C
- Rated voltage / frequency 220-240 V / 50-60 Hz
- Protection class I
- Temperature class T4
- Protection category IP 64

### JSSLED/JBSLED

#### JSHLED/JBHLED

- Suitable for  zone 2 and 22 and industrial lighting
- Approval Conformity declaration
- Explosion protection  II3G Ex ec IIC T4 Gc
-  II3D Ex tc IIIC T68° C Dc IP 64
- CE mark
- LED-Driver
- Ambient temperature -20° C to + 50° C
- Rated voltage / frequency 220-240 V / 50-60 Hz
- Protection class I
- Temperature class T4
- Protection category IP 64

Specifications subject to change



**LIGHT CROSS-SECTION**

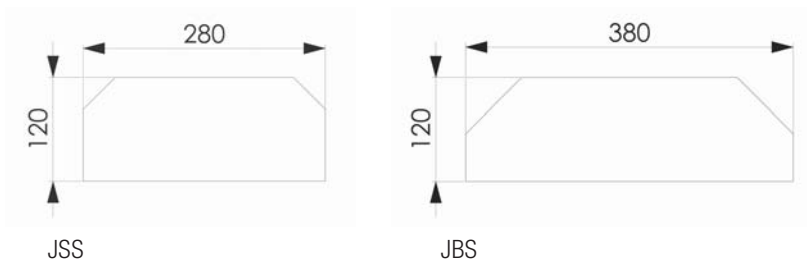

Possible tube fittings in symmetrical version:

- JSS.. 1, 2 and 3 LED strings
- JBS.. 3 and 4 LED strings

Possible tube fittings in asymmetrical version:

- JSS.. 1 LED strings
- JBS.. 2 and 3 LED strings

**LIGHT DISTRIBUTION CURVES**

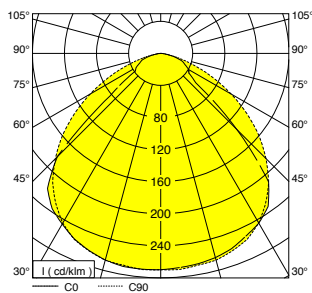

JSSLED 1-LED string symmetrical

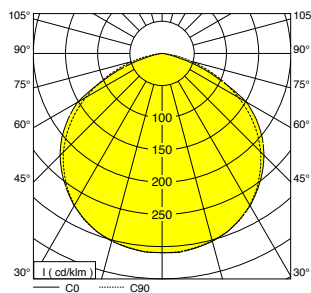

JSSLED 3-LED strings symmetrical

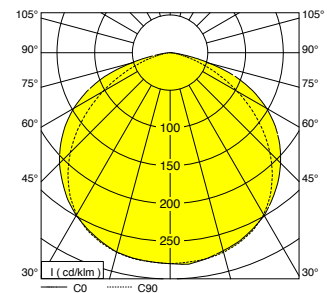

JBSLED 3-LED strings symmetrical

## INTEGRATED LIGHT (WE)

The large mounting frame with the securing holes is welded to the light's casing and can be fitted flush into openings in wall or ceiling elements.

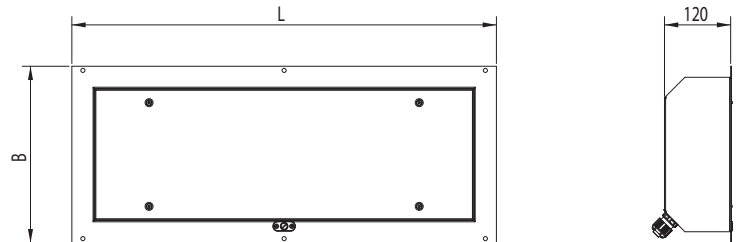

Designation	L	B	Installation-recess	Drawing no.
JSS..-WE...730	770	320	740 x 290	65-011-020-00
JSS..-WE...1340	1380	320	1350 x 290	65-011-040-00
JSS..-WE...1640	1680	320	1650 x 290	65-011-060-00
JBS..-WE...730	770	420	740 x 390	65-001-020-00
JBS..-WE...1340	1380	420	1350 x 390	65-001-040-00
JBS..-WE...1640	1680	420	1650 x 390	65-001-060-00

Further technical details on request

## INTEGRATED WALL LIGHT (ME)

The large mounting frame with the securing holes that is welded to the light's casing has a beveled border, which enables it to be fitted into wall niches.

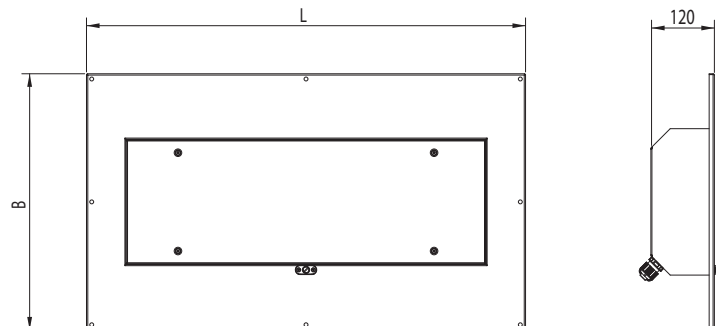

Designation	L	B	Wall recess	Drawing no.
JSS..-ME...730	840	490	790 x 350 x 160	65-011-020-50
JSS..-ME...1340	1450	490	1400 x 350 x 160	65-011-040-50
JSS..-ME...1640	1750	490	1700 x 350 x 160	65-011-060-50
JBS..-ME...730	840	590	790 x 450 x 160	65-001-020-50
JBS..-ME...1340	1450	590	1400 x 450 x 160	65-001-040-50
JBS..-ME...1640	1750	590	1700 x 450 x 160	65-001-060-50

Further technical details on request



### HANGING LAMP (HE)

Due to the threaded rivets at the rear of the lamp, it is possible to hang the lamp from the ceiling or attach it to the mounting. Eyebolts, chains, carabiner or other fastenings are not included in the scope of delivery.

Order accessories separately

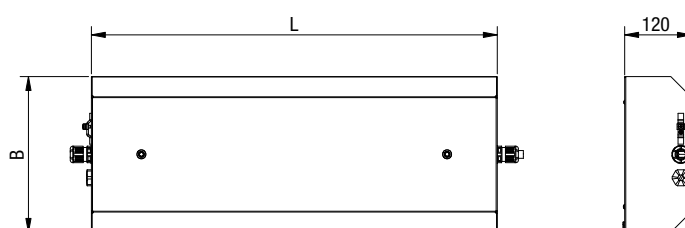

Designation	L	B	Drawing no.
JSS..-HE...730	730	280	65-012-020-00
JSS..-HE...1340	1340	280	65-012-040-00
JSS..-HE...1640	1640	280	65-012-060-00
JBS..-HE...730	730	380	65-002-020-00
JBS..-HE...1340	1340	380	65-002-040-00
JBS..-HE...1640	1640	380	65-002-060-00

Further technical details on request

### LAMP WITH REAR FASTENINGS (RSB)

Due to the threaded rivets at the rear of the lamp, it is possible to hang the lamp from the ceiling or attach it to the mounting. Eyebolts, chains, carabiner or other fastenings are not included in the scope of delivery.

Order accessories separately

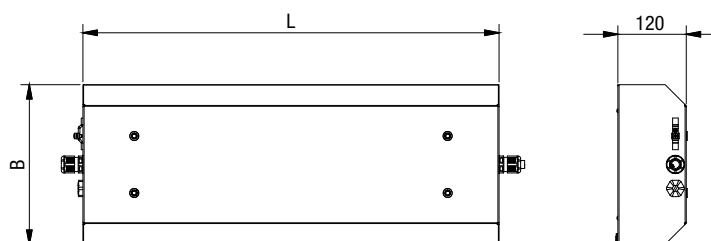

Designation	L	B	Drawing no.
JSS..-RSB...730	730	280	65-017-020-00
JSS..-RSB...1340	1340	280	65-017-040-00
JSS..-RSB...1640	1640	280	65-017-060-00
JBS..-RSB...730	730	380	65-007-020-00
JBS..-RSB...1340	1340	380	65-007-040-00
JBS..-RSB...1640	1640	380	65-007-060-00

Further technical details on request

## ANGULAR INSTALLATION LAMP, HORIZONTAL (SRW)

The lamp is designed for installation in corners between the wall and ceiling. A support bracket is fastened to the wall simplifying the assembly. Sheet metal plates in set or adjustable lengths to compensate for the room length. The supporting brackets are not included in the delivery.

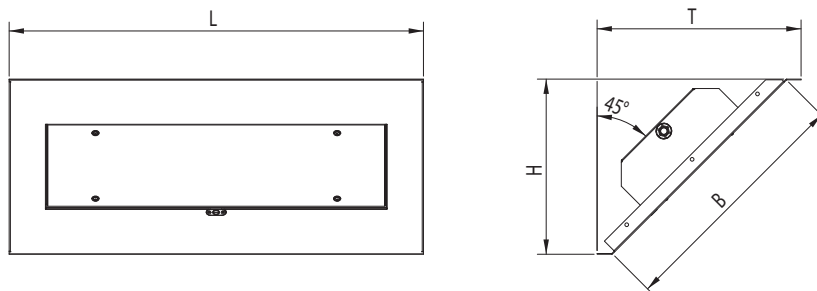

Order accessories separately

Designation	L	B	T	H	Drawing no.
JSS..-SRW...730	840	500	415	355	65-016-020-00
JSS..-SRW...1340	1450	500	415	355	65-016-040-00
JSS..-SRW...1640	1750	500	415	355	65-016-060-00
JBS..-SRW...730	840	520	430	370	65-006-020-00
JBS..-SRW...1340	1450	520	430	370	65-006-040-00
JBS..-SRW...1640	1750	520	430	370	65-006-060-00

Further technical details on request

## ANGULAR INSTALLATION LAMP, VERTICAL (SRS)

These lights are designed for vertical installation in corners. Side fixing holes are provided in the frame for installing the light fitting. Sloped covers are available to prevent any accumulation of dust.

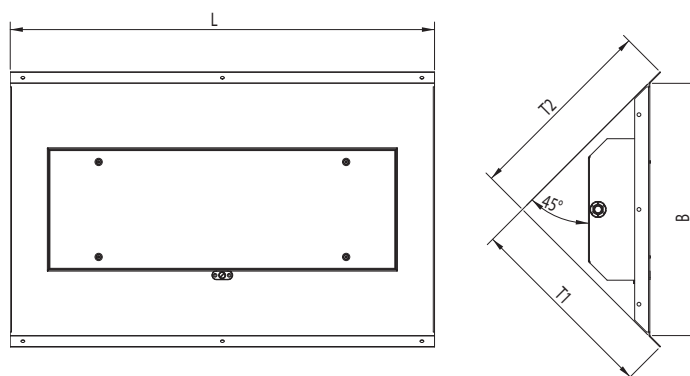

Order accessories separately

Designation	L	B	T1	T2	Drawing no.
JSS..-SRS...730	840	500	385	385	65-016-020-01
JSS..-SRS...1340	1450	500	385	385	65-016-040-03
JSS..-SRS...1640	1750	500	385	385	65-016-060-02
JBS..-SRS...730	840	520	400	400	65-006-020-01
JBS..-SRS...1340	1450	520	400	400	65-006-040-02
JBS..-SRS...1640	1750	520	400	400	65-006-060-02

Further technical details on request



## SWIVELLING LIGHT (SW)

The front stud bolt enables vertical or horizontal fitting onto the mount. The light can be swiveled into any position.

Accessories to be ordered separately

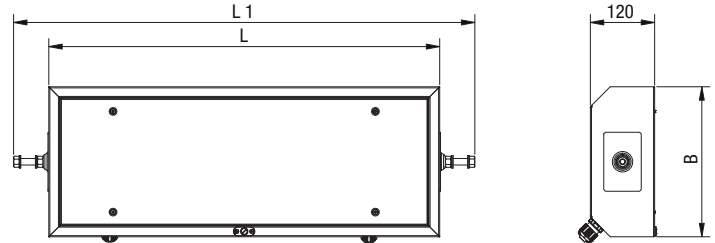

Designation	L1	L	B	Drawing no.
JSS..-SW...730	860	730	280	65-014-020-00
JSS..-SW...1340	1470	1340	280	65-014-040-00
JSS..-SW...1640	1770	1640	280	65-014-060-00
JBS..-SW...730	860	730	380	65-004-020-00
JBS..-SW...1340	1470	1340	380	65-004-040-00
JBS..-SW...1640	1770	1640	380	65-004-060-00

Further technical details on request

## WALL FIXING BRACKET FOR JSS + JBS

Wall fixing bracket made of sheet steel, galvanised or stainless.

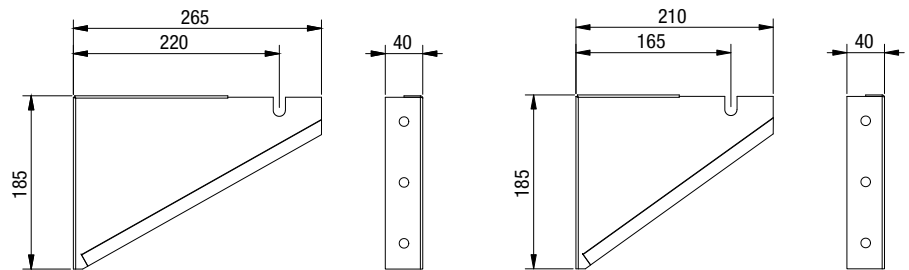

Further technical details on request

Wide version

Narrow version

## CEILING FIXING BRACKET FOR JSS + JBS

Ceiling fixing bracket made of sheet steel, galvanised or stainless.

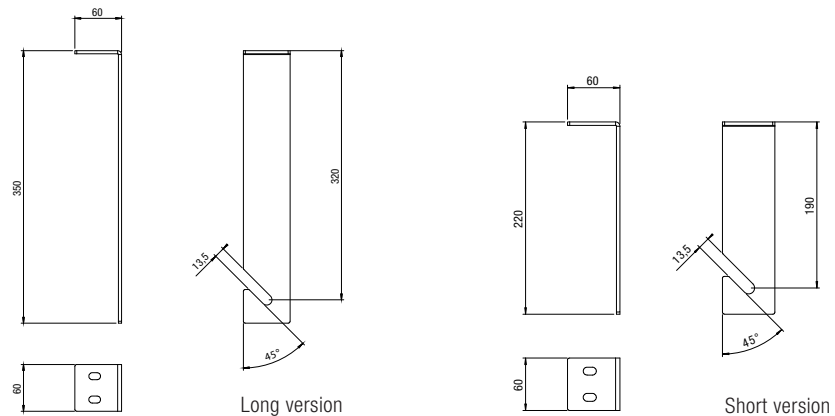

Further technical details on request

Long version

Short version

The JUNG JSH and JBH lighting range is identical to the JSS and JBS models. The difference lies in the type of installation.

## LIGHT CROSS-SECTION

Possible fittings in symmetrical version:

- JSH.. 1, 2 and 3 LED strings
- JBH.. 3 and 4 LED strings

Possible fittings in asymmetrical version

- JSH.. 1 LED strings
- JBH.. 2 and 3 LED strings

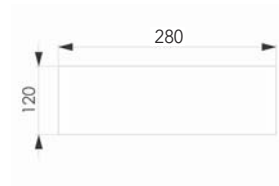

JSH

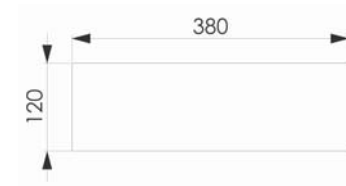

JBH

## SURFACE-MOUNTED LIGHT (AB)

A reasonably priced, high quality surface-mounted light. The securing frame welded onto the back of the light fitting enables it to be fitted as a surface-mounted wall or ceiling light.

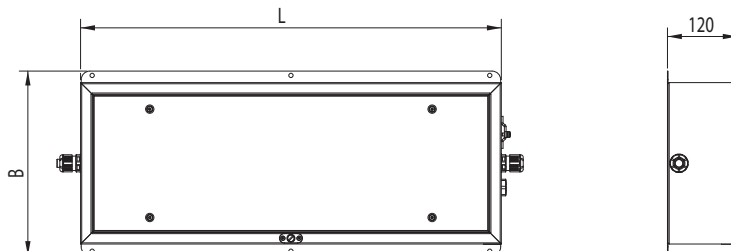

Designation	L	B	Drawing no.
JSH..-AB...730	730	320	65-035-020-50
JSH..-AB...1340	1340	320	65-035-040-50
JSH..-AB...1640	1640	320	65-035-060-50
JBH..-AB...730	730	420	65-025-020-50
JBH..-AB...1340	1340	420	65-025-040-50
JBH..-AB...1640	1640	420	65-025-060-50

Further technical details on request

## SURFACE-MOUNTED WALL LIGHT, HORIZONTAL (WAW)

The light fitting is designed for horizontal wall mounting. Securing holes are provided at the top and bottom. To prevent dust accumulating, the casing has a slope of 45° at the top.

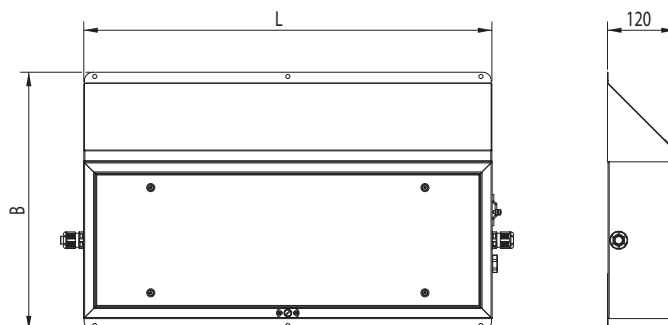

Designation	L	B	Drawing no.
JSH..-WAW...730	730	460	65-038-020-00
JSH..-WAW...1340	1340	460	65-038-040-00
JSH..-WAW...1640	1640	460	65-038-060-00
JBH..-WAW...730	730	560	65-028-020-00
JBH..-WAW...1340	1340	560	65-028-040-00
JBH..-WAW...1640	1640	560	65-028-060-00

Further technical details on request

## SURFACE-MOUNTED WALL LIGHT, VERTICAL (WAS)

The light fitting is designed for vertical wall mounting. Securing holes are provided at side. To prevent dust accumulating, the casing has a slope of 45° at the top.

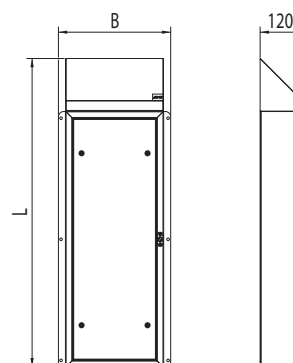

Bezeichnung	L	B	Zeichnungs-Nr.
JSH..-WAS...730	880	320	65-039-020-00
JSH..-WAS...1340	1490	320	65-039-040-00
JSH..-WAS...1640	1790	320	65-039-060-00
JBH..-WAS...730	880	420	65-029-020-00
JBH..-WAS...1340	1490	420	65-029-040-00
JBH..-WAS...1640	1790	420	65-029-060-00

Further technical details on request

The special features of these JUNG luminaires are the slim casing depth of 80mm and their suitability for use up to  $\text{Ex}$  zone 1 and 21.

## TECHNICAL DATA

### JSNLED/JBNLED

#### JSSNLED

- Suitable for  $\text{Ex}$  zone 2 + 22
- Approval Conformity declaration
- Explosion protection
  - $\text{Ex}$  II3G Ex ec IIC T4 Gc
  - $\text{Ex}$  II3D Ex tc IIIC T68° C Dc
- $\text{CE}$  mark
- LED-Driver
- Ambient temperature
  - 20° C to + 50° C
- Rated voltage / frequency
  - 220-240 V / 50-60 Hz
- Protection class I
- Temperature class T4
- Protection category IP 64

Specifications subject to change

## LIGHT CROSS-SECTION

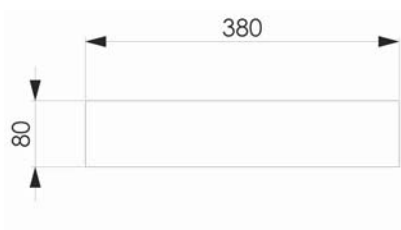

JSN



JBN

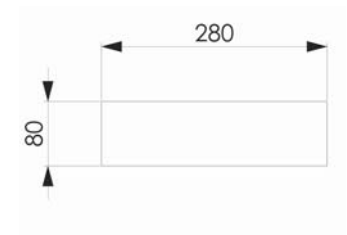

JSSN

Possible tube fittings in symmetrical version:

- Ex-Zone 2 and 22 = JSSNLED..1 and 2 LED strings
- Ex-Zone 2 and 22 = JSNLED.. 3 and 4 LED strings
- Ex-Zone 2 and 22 = JBNLED.. 3 and 4 LED strings

Possible tube fittings in asymmetrical version:

- Ex-Zone 2 and 22 = JSNLED.. 2 and 3 LED strings
- Ex-Zone 2 and 22 = JBNLED.. 3 and 4 LED strings
- Ex-Zone 2 and 22 = JSSNLED.. 1 LED string

## INTEGRATED LIGHT (WE)

This light fitting features a slim casing depth of 80mm, which enables it to be fitted in walls or ceilings with modest recess installation measurements. The mounting frame with the securing holes is welded to the light's casing and can be fitted flush into wall or ceiling openings.

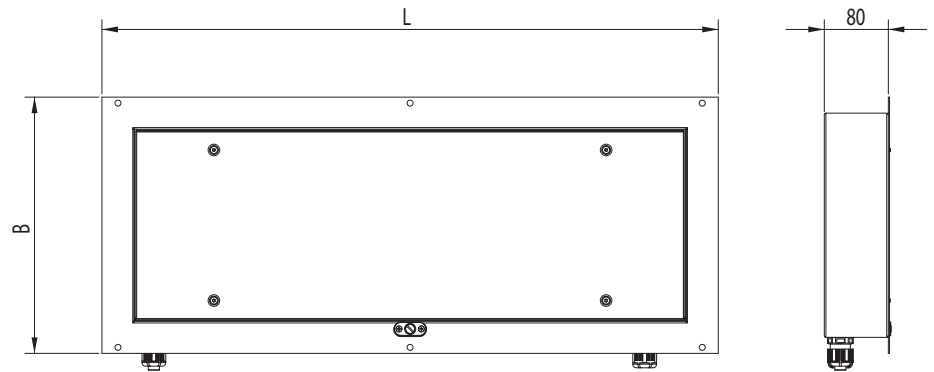

Designation	L	B	Installation recess	Drawing no.
JSSN..-WE...730	770	320	740 x 290	65-091-020-00
JSSN..-WE...1340	1380	320	1350 x 290	65-091-040-00
JSSN..-WE...1640	1680	320	1650 x 290	65-091-060-00
JSN..-WE...730	770	420	740 x 390	65-051-020-00
JSN..-WE...1340	1380	420	1350 x 390	65-051-040-00
JSN..-WE...1640	1680	420	1650 x 390	65-051-060-00
JBN..-WE...730	770	520	740 x 490	65-041-020-00
JBN..-WE...1340	1380	520	1350 x 490	65-041-040-00
JBN..-WE...1640	1680	520	1650 x 490	65-041-060-00

Further technical details on request



## SURFACE-MOUNTED LIGHT (AB)

The light fittings are designed as wall or ceiling lights. The slim casing depth of 80mm enables them to be used in areas where there is little space. The securing frame welded onto the back enables these lights to be fitted as surface-mounted wall or ceiling lights.

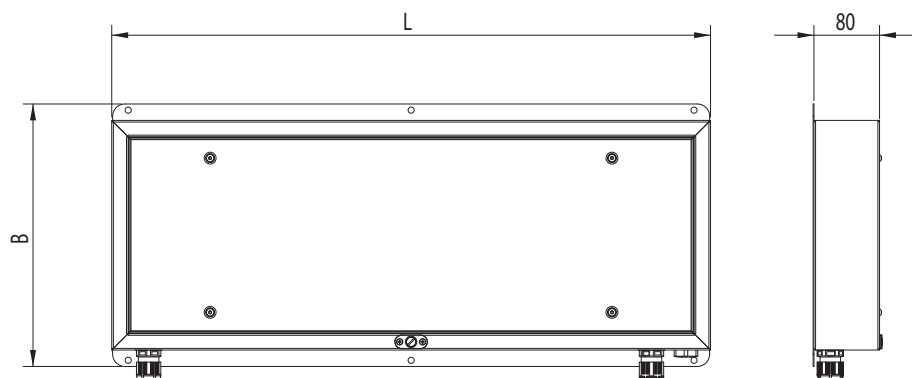

Designation	L	B	Drawing no.
JSSN..-AB...730	730	320	65-095-020-50
JSSN..-AB...1340	1340	320	65-095-040-50
JSSN..-AB...1640	1640	320	65-095-060-50
JSN..-AB...730	730	420	65-055-020-50
JSN..-AB...1340	1340	420	65-055-040-50
JSN..-AB...1640	1640	420	65-055-060-50
JBN..-AB...730	730	520	65-045-020-50
JBN..-AB...1340	1340	520	65-045-040-50
JBN..-AB...1640	1640	520	65-045-060-50

Further technical details on request